

Helping Customers Innovate, Improve & Grow



VX-990

### Features

- Ultra low Phase Noise
- Ultra low G-Sensitivity
- Vibration hardened
- Tight Tolerances

### Applications

- Vibration Environment
- Airborne and Military Equipment
- Portable Equipment
- Radar

Frequency Range  
Standard Frequencies

60 MHz – 120 MHz  
120 MHz

## Performance Specifications

Frequency Stabilities <sup>1</sup>						
Parameter	Min	Typical	Max	Units	Condition	Options <sup>3</sup>
vs. operating temperature range (referenced to nominal frequency)	-15.0		+15.0	ppm	-20 to +70°C	
	-25.0		+25.0	ppm	-40 to +85°C	
Initial tolerance	-15.0		+15.0	ppm	25°C	
vs. supply voltage change	-0.1		+0.1	ppm	$V_s \pm 5\%$ static	
vs. load change	-0.1		+0.1	ppm	Load $\pm 10\%$ static	
vs. aging / 1 year	-1.0		+1.0	ppm	after 30 days of operation	
vs. aging / 10 years	-3.0		+3.0	ppm	after 30 days of operation	

## Performance Specifications

Supply Voltage (Vs)						
Parameter	Min	Typical	Max	Units	Condition	
Supply voltage (standard)	14.25	15	15.75	VDC		
Current consumption			100	mA		
RF Output						
Signal [standard]	Sinewave				50 Ω load	
Load	45	50	55	Ohm		
Output Power	10	13	16	dBm	50 Ω load	
Harmonics			-30	dBc	50 Ω load	
Spurious			-80	dBc	50 Ω load	
Frequency Tuning (EFC)						
Absolute Pulling Range	±0.0			ppm	Pulling range is sufficient to tune the oscillator over lifetime of 10 years and all circumstances to nominal frequency	
Tuning Slope	Positive					
Control Voltage Range	-4	0	+4	VDC		
Frequency control input impedance	50			kOhm		
Additional Parameters						
Phase Noise <sup>2</sup>		-90 -125 -153 -167 -173 -175		dBc/Hz dBc/Hz dBc/Hz dBc/Hz dBc/Hz dBc/Hz	10 Hz 100 Hz 1 kHz 10 kHz 100 kHz 1 MHz	@ 120 MHz 13 dBm sinewave no vibration
G-Sensitivity		0.5		ppb/g	without shock absorbers <sup>3</sup>	
G-Sensitivity			1	ppb/g	optional without shock absorbers <sup>3</sup>	
G-Sensitivity			0.5	ppb/g	optional without shock absorbers <sup>3</sup>	
Weight		55	75	g		
Processing & Packing	Handling & Processing Note					
Additional Environmental Conditions						
Random Vibration	RTCA/DO-160 D, Section 8, Category R or R2 curve C and C1					
Shock	MIL-STD-202G; Method 213B; 15 g / 20 ms				for softest shock absorber i.e. lowest resonance frequency	
Solderability	JEDEC J-STD-002 non RoHS compliant					
Solvent Resistance	non-washable device					
Absolute Maximum Ratings						
Supply voltage (Vs)			16.0	V		
Output Load	45		55	Ω		
Operable Temperature Range	-40		+85	°C		
Storage Temperature Range	-55		+105	°C		

# Outline Drawing / Enclosure

Parameter	Min	Typical	Max	Units	Condition
G295 including vibration isolators. Mechanical resonance frequency	35		110	Hz	Please specify vibration profile and phase noise max values under vibration

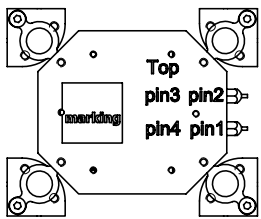
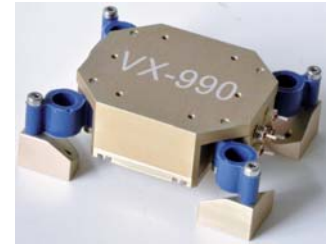
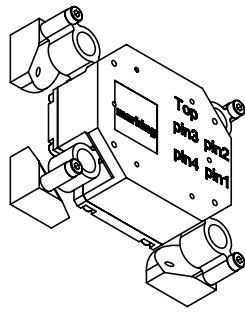
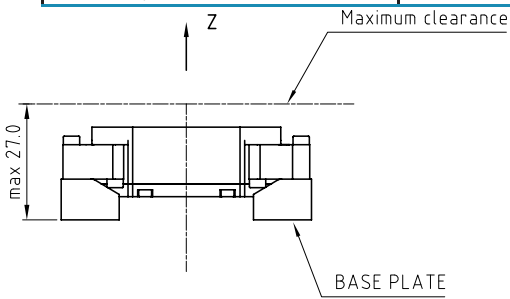

Dimensions in mm

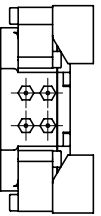
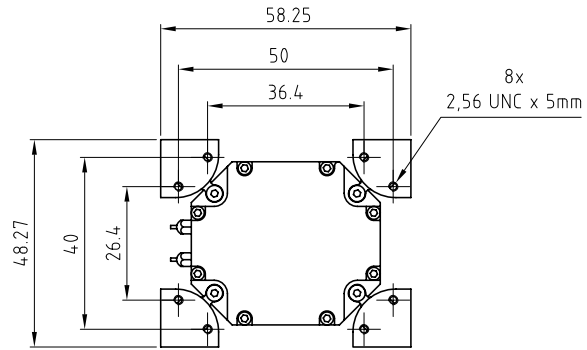
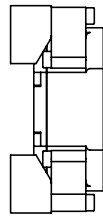

Parameter	Min	Typical	Max	Units	Condition
G313 without vibration isolators.					Option please specify vibration profile and phase noise max values under vibration

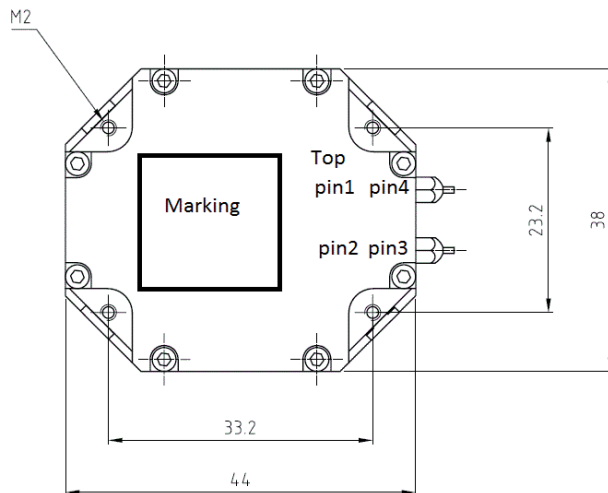
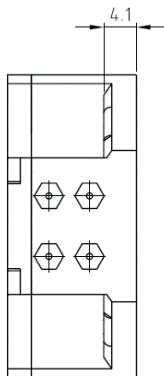
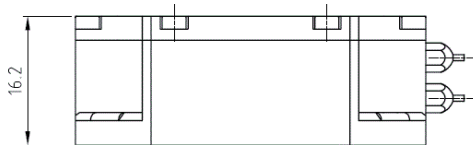

Dimensions in mm

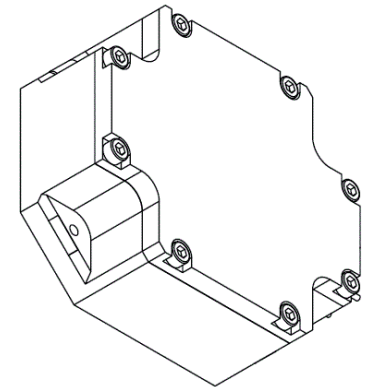

Pin Connections	
1	Control Voltage Input (Vc)
2	Supply Voltage (Vs)
3	RF-Output
4	Ground (Case)

# Typical Phase Noise @ 120 MHz without vibration

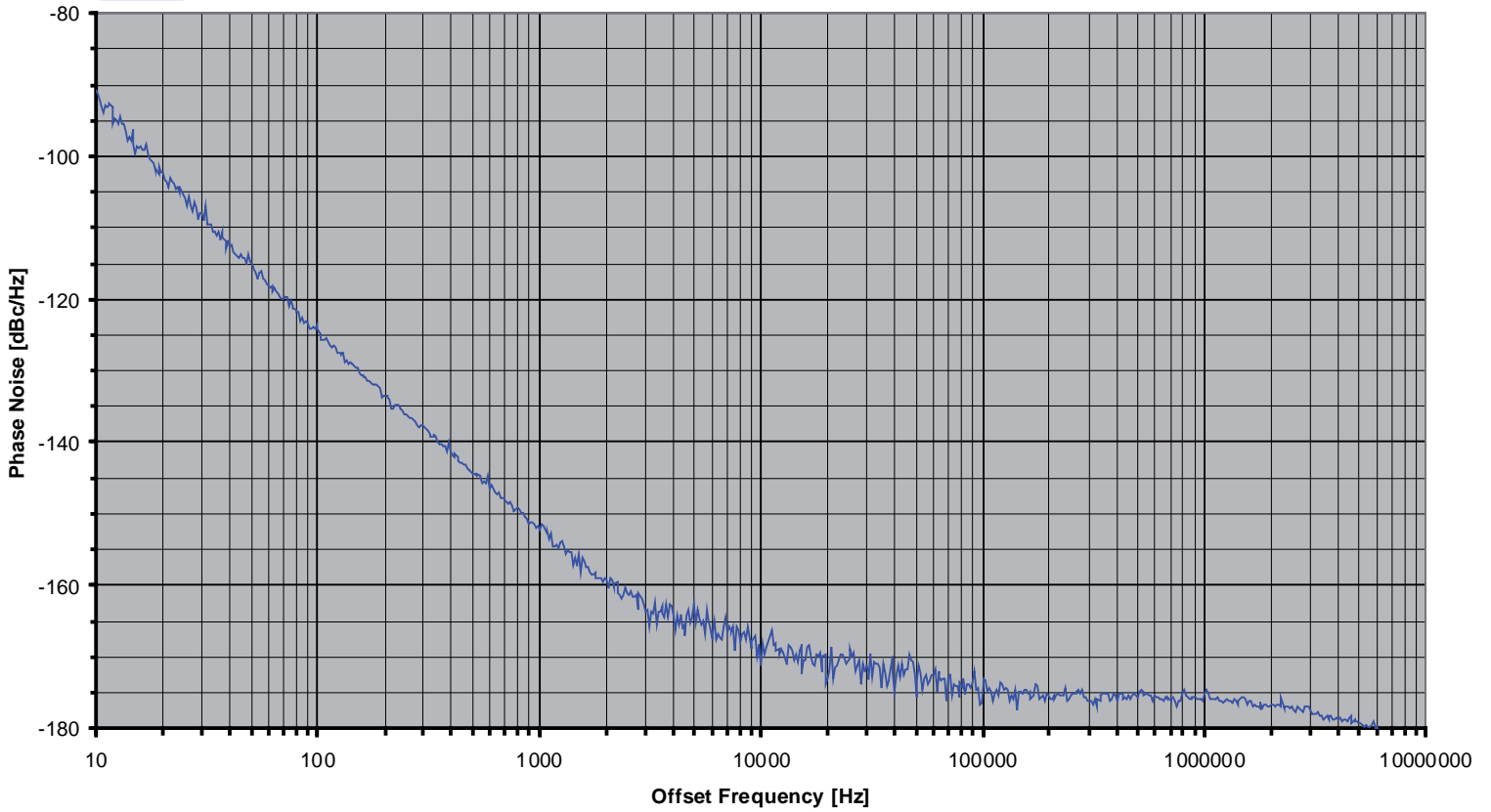

# Typical G-Sensitivity @120 MHz without shock absorber

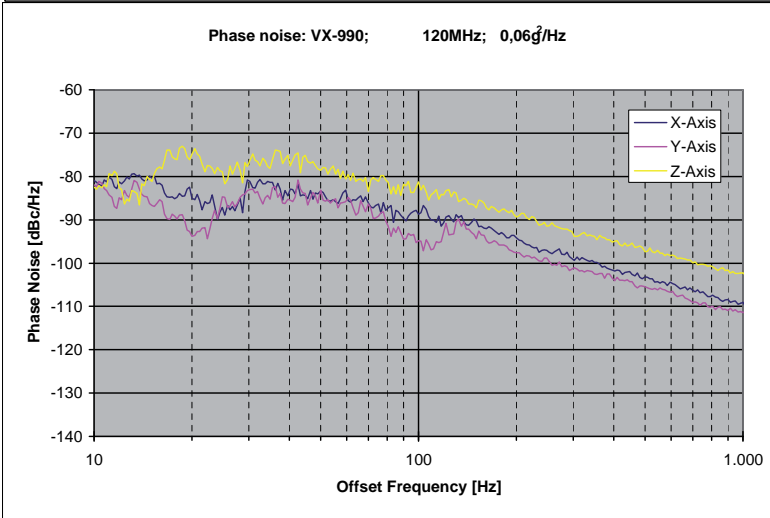
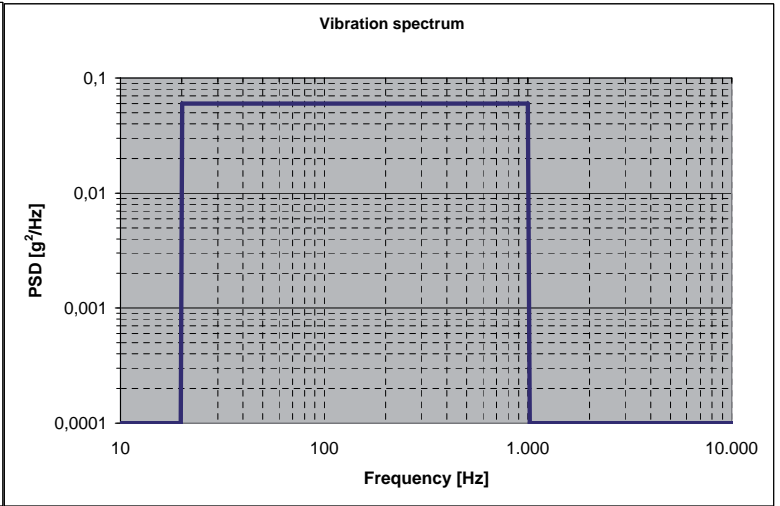
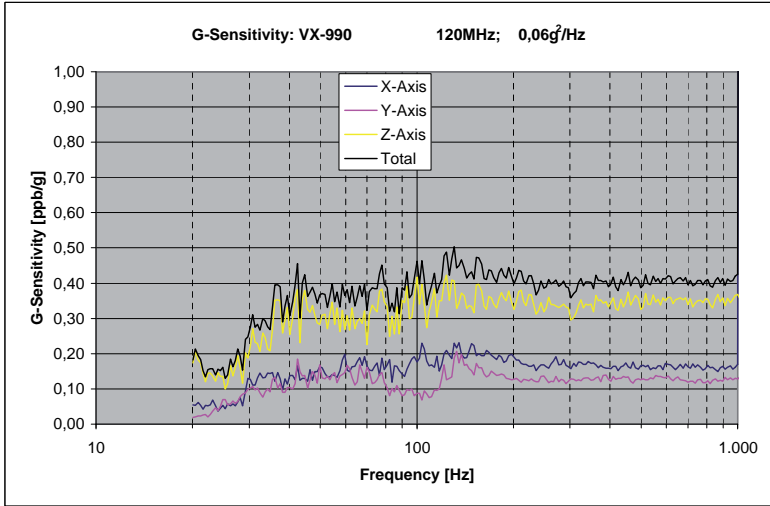

Calculation equation according to Vig-Tutorial

$$g\text{-sensitivity: } G = \frac{2 \cdot f_v}{A_{peak} \cdot f_0} \cdot 10^{\frac{L(f_v)}{20}}$$

$$\text{Peak g-level: } A_{peak} = \sqrt{PSD \cdot 2}$$

Comments:  
Measured without shock absorbers

# Typical Frequency Stability vs Temperature

## Frequency vs. Temperature

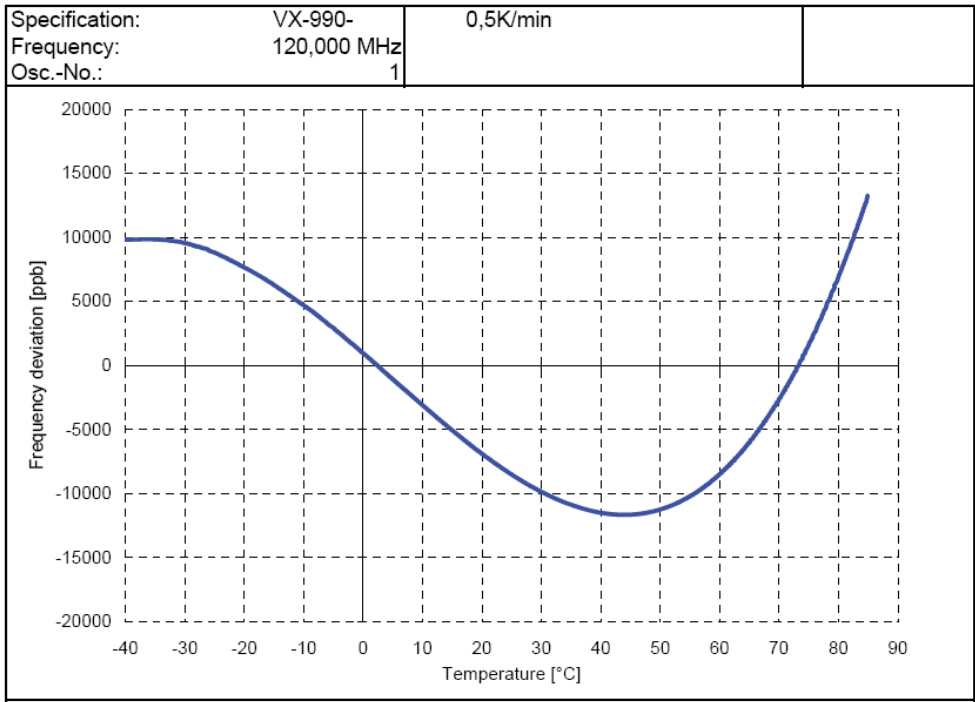

# Typical Phase Noise @ 120 MHz with vibration

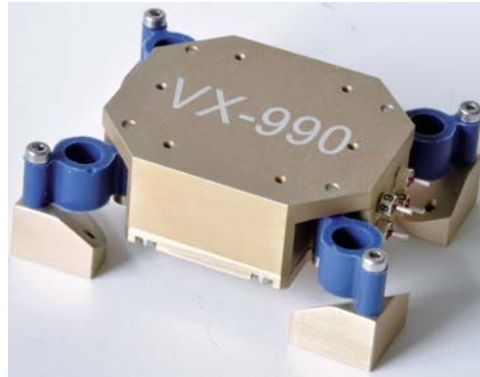
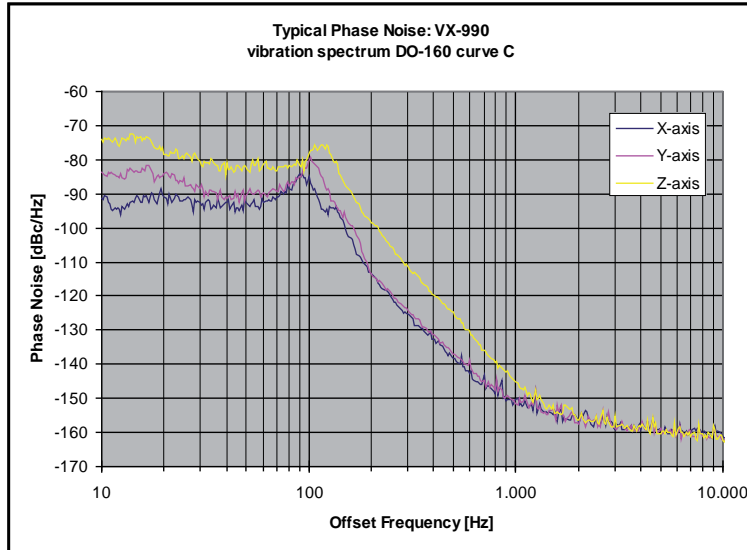
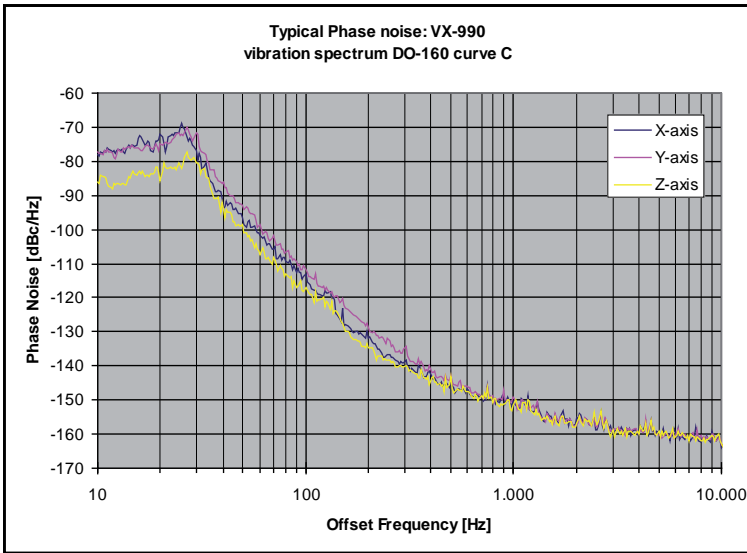
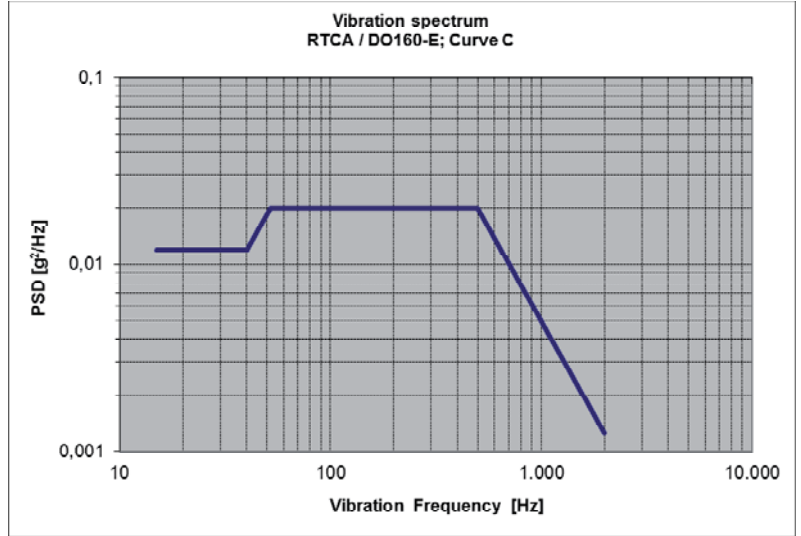
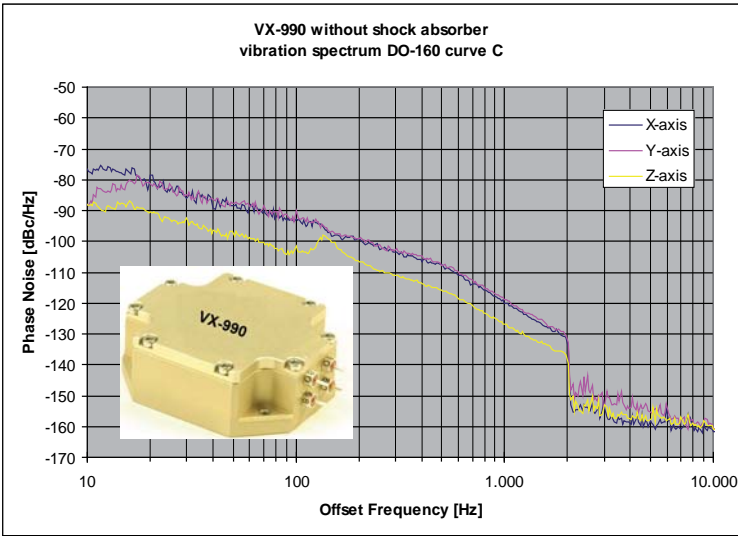

## Ordering Information

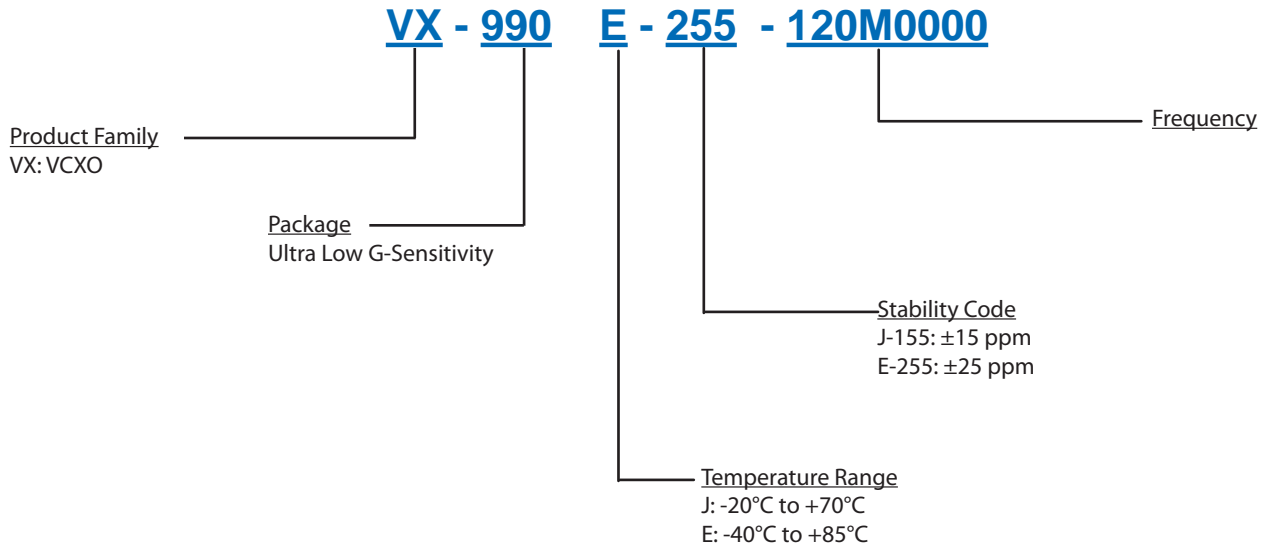

### Notes:

1. Contact factory for improved stabilities or additional product options. Not all options and codes are available at all frequencies.
2. Phase noise degrades with increasing output frequency.
3. Contact factory for availability.

Unless other stated all values are valid after warm-up time and refer to typical conditions for supply voltage, frequency control voltage, load, temperature (25°C).

Subject to technical modification.

## For Additional Information, Please Contact

### USA:

Vectron International  
267 Lowell Road  
Hudson, NH 03051  
Tel: 1.888.328.7661  
Fax: 1.888.329.8328

### Europe:

Vectron International  
Landstrasse, D-74924  
Neckarbischofsheim, Germany  
Tel: +49 (0) 7268.801.100  
Fax: +49 (0) 7268.801.282

### Asia:

Vectron International  
1589 Century Avenue, the 19th Floor  
Chamtime International Financial Center  
Shanghai, China  
Tel: 86.21.6081.2888  
Fax: 86.21.6163.3598

### Disclaimer

Vectron International reserves the right to make changes to the product(s) and or information contained herein without notice. No liability is assumed as a result of their use or application. No rights under any patent accompany the sale of any such product(s) or information.

Rev: 10/2011